



Selection: Semi-hermetic Reciprocating Compressors

Input Values

Compressor model	(6F-50.2Y)	Suction gas temperature	20,00 °C
Mode	Refrigeration and Air conditioning	Operating mode	Auto
Refrigerant	R404A	Power supply	400V-3-50Hz
Reference temperature	Dew point temp.	Capacity control	100%
Liq. subc. (in condenser)	0 K	Useful superheat	100%

Result

Q [W]	Cooling capacity	COP [-]	COP/EER
Qu* [W]	Evaporator capacity	m [kg/h]	Mass flow
P [kW]	Power input	Op.	Operating mode
I [A]	Current	th [°C]	Discharge gas temp. w/o cooling
Qc [W]	Condenser capacity		

tc	to	0°C	-5°C	-10°C	-15°C	-20°C	-25°C	-30°C	-35°C
30°C	Q [W]	142143	118566	98113	80413	65152	52055	40878	31403
	Qu* [W]	142143	118566	98113	80413	65152	52055	40878	31403
	P [kW]	34,5	32,9	30,9	28,8	26,4	23,9	21,4	18,79
	I [A]	72,1	70,1	67,8	65,0	61,9	58,5	55,0	51,5
	Qc [W]	176632	151434	129059	109195	91580	75997	62255	50190
	COP [-]	4,12	3,61	3,17	2,79	2,47	2,17	1,91	1,67
	m [kg/h]	3613	2979	2440	1984	1596	1267	990	758
	Op.	Standard	Standard	Standard	Standard	Standard	Standard	Standard	Standard
	th [°C]	65,6	72,0	78,7	85,9	93,7	102,2	111,8	122,9
	40°C	Q [W]	121655	101314	83614	68260	54994	43592	33850
Qu* [W]		121655	101314	83614	68260	54994	43592	33850	25582
P [kW]		39,8	37,2	34,4	31,5	28,4	25,3	22,2	19,09
I [A]		78,1	75,2	72,0	68,4	64,5	60,3	56,1	51,9
Qc [W]		161446	138531	118036	99723	83390	68866	56002	44670
COP [-]		3,06	2,72	2,43	2,17	1,94	1,72	1,53	1,34
m [kg/h]		3490	2868	2341	1893	1513	1191	920	692
Op.		Standard	Standard	Standard	Standard	Standard	Standard	Standard	Standard
th [°C]		76,3	82,7	89,4	96,6	104,4	113,0	122,9	134,7
50°C		Q [W]	100799	83780	68915	55985	44794	35165	26936
	Qu* [W]	100799	83780	68915	55985	44794	35165	26936	19957
	P [kW]	44,8	41,3	37,6	33,8	30,0	26,2	22,5	18,97
	I [A]	83,6	79,7	75,6	71,3	66,6	61,6	56,6	51,8
	Qc [W]	145645	125073	106515	89807	74809	61398	49467	38922
	COP [-]	2,25	2,03	1,83	1,66	1,49	1,34	1,20	1,05
	m [kg/h]	3357	2748	2231	1793	1422	1107	843	621
	Op.	Standard	Standard	Standard	Standard	Standard	Standard	Standard	Standard
	th [°C]	87,6	94,0	100,7	107,9	115,8	124,5	134,6	0



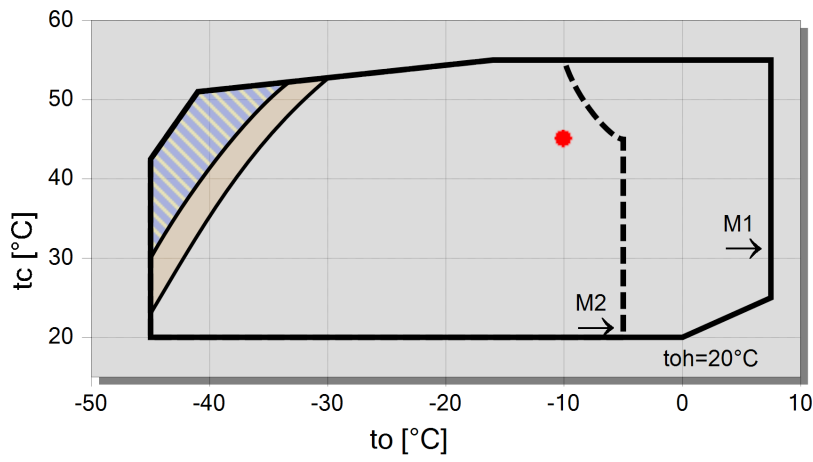

-- No calculation possible (see message in single point selection)

*According to EN12900 (20°C suction gas temp., 0K liquid subcooling)

Application Limits 100% 6F-50.2



Legend

-  additional cooling & suction gas superheat $\leq 20K$
-  additional cooling or max. toh $< 0^\circ C$
-  M1: motor 1
-  M2: motor 2
-  A



Technical Data: (6F-50.2Y)

Dimensions and Connections

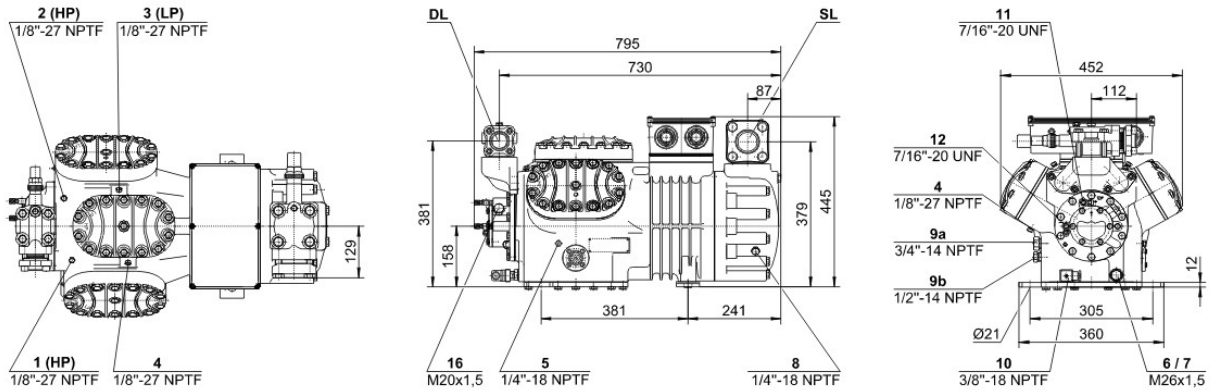

Technical Data

Technical Data

Displacement (1450 RPM 50Hz)	151,6 m ³ /h
Displacement (1750 RPM 60Hz)	183,07 m ³ /h
No. of cylinder x bore x stroke	6 x 82 mm x 55 mm
Weight	241 kg
Max. pressure (LP/HP)	19 / 28 bar
Connection suction line	54 mm - 2 1/8"
Connection discharge line	42 mm - 1 5/8"
Connection cooling water	R 3/4"
Oil type R134a/R407C/R404A/R507A/R407A/R407F	tc<55°C: BSE32 tc>55°C: BSE55 (Option)
Oil type R22 (R12/R502)	B5.2 (Standard)
Oil type R290/R1270	SHC226E (Standard)

Motor data

Motor voltage (more on request)	380-400V PW-3-50Hz
Max operating current	92.0 A
Winding ratio	50/50
Starting current (Rotor locked)	226.0 A Y / 404.0 A YY
Max. Power input	53,2 kW

Extent of delivery (Standard)

Motor protection	SE-B2
Enclosure class	IP54 (Standard), IP66 (Option)
Vibration dampers	Standard
Oil charge	4,75 dm ³

Available Options

Connection suction line	Option
Discharge shut-off valve	Option
Discharge gas temperature sensor	Option
Start unloading	Option
Capacity control	100-66-33% (Option)
Additional fan	Option
Water-cooled cylinder heads	Option
Oil service valve	Option
Crankcase heater	140 W (Option)
Oil pressure monitoring	MP54 (Option), Delta-PII (Option, not for R290/R1270)

Sound measurement

Sound power level (+5°C / 50°C)	84,0 dB(A) @ 50Hz
Sound power level (-10°C / 45°C)	83,0 dB(A) @ 50Hz
Sound power level (-35°C / 40°C)	(91,5) dB(A) @ 50Hz
Sound pressure level @ 1m (+5°C / 50°C)	76,0 dB(A) @ 50Hz



Sound pressure level @ 1m (-10°C / 45°C)

75,0 dB(A) @ 50Hz

Sound pressure level @ 1m (-35°C / 40°C)

(83,5) dB(A) @ 50Hz



Semi-hermetic Reciprocating Compressors

Motor 1 = e.g. 4TES-12 with 12"HP", primary for air-conditioning (e.g. R22,R407C) and air-conditioning with R134a at high ambient temperatures.

Motor 2 = e.g. 4TES-9 with 8"HP", universal Motor for medium and low temperature application (e.g. R404A, R507A, R407A, R407F) and air-conditioning with R134a

Motor 3 = e.g. 4TES-8, for medium temperature applications and R134a

For more information concerning the application range use the "Limits" button.

Operation modes 4VES-7 to 6FE-44 and 44JE-30 to 66FE-88 with R407F/R407A/R22

CIC = liquid injection with low temperature application, suction gas cooled motor.

ASERCOM certified performance data

The Association of European Refrigeration Component Manufacturers has implemented a procedure of certifying performance data. The high standard of these certifications is assured by:

- * plausibility tests of the data performed by experts.
- * regular measurements at independent institutes.

These high efforts result in the fact that only a limited number of compressors can be submitted. Due to this not all BITZER compressors are certified until now. Performance data of compressors which fulfil the strict requirements may carry the label "ASERCOM certified". In this software you will find the label at the respective compressors on the right side below the field "result" or in the print out of the performance data. All certified compressors and further information are listed on the homepage of ASERCOM.

Condensing capacity

The condensing capacity can be calculated with or without heat rejection. This option can be set in the menu Program Options. The heat rejection is constantly 5% of the power consumption. The condensing capacity is to be found in the line Condensing cap. (with HR) resp. Condensing capacity.

Data for sound emission

Data based on 50HZ application (IP-units 60Hz) and R404A if not declared.

Sound pressure level: values based on free field area conditions with hemispherical sound emission in 1 meter distance.

General remarks regarding sound data

Listed sound data were measured under testing conditions in our laboratory. For this purpose the free-standing test sample is mounted on a solid foundation plate and the pipework is connected vibration-free to the largest extend possible. Suction and discharge lines are fixed in a flexible configuration, such that a transmission of vibrations to the environment can be largely excluded. In real installations considerable differences might be observed, compared to the measurements in the laboratory. The airborne sound emitted by the compressor can be reflected from surfaces of the system and this may increase the airborne sound level measured close to the compressor. Vibrations caused by the compressor are also transferred to the system by the compressor feet and piping depending on the damping ratio of the fixings. Thus, the vibrations can induce other components to such an extent that these components contribute to an increase in airborne sound emission. If required, the transfer of vibrations to the system can be minimized by suitable fixing and damping elements.

Legend of connection positions according to "Dimensions":

- 1 High pressure connection (HP)
- 2 Connection for discharge gas temperature sensor (HP) (for 4VE(S)-6Y .. 4NE(S)-20(Y) connection for CIC sensor as alternative)
- 3 Low pressure connection (LP)
- 4 CIC system: injection nozzle (LP)
- 4b Connection for CIC sensor
- 4c Connection for CIC sensor (MP / operation with liquid subcooler)
- 5 Oil fill plug
- 6 Oil drain
- 7 Oil filter (magnetic screw)
- 8 Oil return (oil separator)
- 8* Oil return with NH3 and insoluble oil
- 9 Connection for oil and gas equalization (parallel operation)
- 9a Connection for gas equalization (parallel operation)



- 9b Connection for oil equalization (parallel operation)
 - 10 Oil heater connection
 - 11 Oil pressure connection +
 - 12 Oil pressure connection –
 - 13 Cooling water connection
 - 14 Intermediate pressure connection (MP)
 - 15 Liquid injection (operation without liquid subcooler and with thermostatic expansion valve)
 - 16 Connection for oil monitoring (opto-electrical oil monitoring "OLC-K1" or differential oil pressure switch "Delta-PII")
 - 17 Refrigerant inlet at liquid subcooler
 - 18 Refrigerant outlet at liquid subcooler
 - 19 Clamp space
 - 20 Terminal plate
 - 21 Maintenance connection for oil valve
 - 22 Pressure relief valve to the atmosphere (discharge side)
 - 23 Pressure relief valve to the atmosphere (suction side)
 - 24 IQ MODULE
 - SL Suction gas line
 - DL Discharge gas line
- Dimensions can show tolerances according to EN ISO 13920-B.